

TECHNICAL REVIEW

Properties and Calibration of Laboratory
Standard Microphones

Uncertainties in Microphone Frequency
Responses



No.1 2001

Previously issued numbers of Brüel & Kjær Technical Review

- 1 – 2000 Non-stationary STSF
- 1 – 1999 Characteristics of the vold-Kalman Order Tracking Filter
- 1 – 1998 Danish Primary Laboratory of Acoustics (DPLA) as Part of the National Metrology Organisation
Pressure Reciprocity Calibration – Instrumentation, Results and Uncertainty
MP.EXE, a Calculation Program for Pressure Reciprocity Calibration of Microphones
- 1 – 1997 A New Design Principle for Triaxial Piezoelectric Accelerometers
A Simple QC Test for Knock Sensors
Torsional Operational Deflection Shapes (TODS) Measurements
- 2 – 1996 Non-stationary Signal Analysis using Wavelet Transform, Short-time Fourier Transform and Wigner-Ville Distribution
- 1 – 1996 Calibration Uncertainties & Distortion of Microphones.
Wide Band Intensity Probe. Accelerometer Mounted Resonance Test
- 2 – 1995 Order Tracking Analysis
- 1 – 1995 Use of Spatial Transformation of Sound Fields (STSF) Techniques in the Automotive Industry
- 2 – 1994 The use of Impulse Response Function for Modal Parameter Estimation
Complex Modulus and Damping Measurements using Resonant and Non-resonant Methods (Damping Part II)
- 1 – 1994 Digital Filter Techniques vs. FFT Techniques for Damping Measurements (Damping Part I)
- 2 – 1990 Optical Filters and their Use with the Type 1302 & Type 1306 Photoacoustic Gas Monitors
- 1 – 1990 The Brüel & Kjær Photoacoustic Transducer System and its Physical Properties
- 2 – 1989 STSF — Practical Instrumentation and Application
Digital Filter Analysis: Real-time and Non Real-time Performance
- 1 – 1989 STSF — A Unique Technique for Scan Based Near-Field Acoustic Holography Without Restrictions on Coherence
- 2 – 1988 Quantifying Draught Risk
- 1 – 1988 Using Experimental Modal Analysis to Simulate Structural Dynamic Modifications
Use of Operational Deflection Shapes for Noise Control of Discrete Tones
- 4 – 1987 Windows to FFT Analysis (Part II)
Acoustic Calibrator for Intensity Measurement Systems
- 3 – 1987 Windows to FFT Analysis (Part I)
- 2 – 1987 Recent Developments in Accelerometer Design
Trends in Accelerometer Calibration

(Continued on cover page 3)

Technical Review

No. 1 – 2001

Contents

The Influence of Environmental Conditions on the Pressure Sensitivity of Measurement Microphones	1
<i>Knud Rasmussen, Danish Technical University</i>	
Reduction of Heat Conduction Error in Microphone Pressure Reciprocity Calibration.....	14
<i>Erling Frederiksen</i>	
Frequency Response for measurement microphones – a question of confidence	24
<i>Johan Gramtorp and Erling Frederiksen</i>	
Measurement of microphone random-incidence and pressure-field responses and determination of their uncertainties	36
<i>Johan Gramtorp and Erling Frederiksen</i>	

Copyright © 2001, Brüel & Kjær Sound & Vibration Measurement A/S
All rights reserved. No part of this publication may be reproduced or distributed in any form, or by any means, without prior written permission of the publishers. For details, contact:
Brüel & Kjær Sound & Vibration Measurement A/S, DK-2850 Nærum, Denmark.

Editor: Harry K. Zaveri

The Influence of Environmental Conditions on the Pressure Sensitivity of Measurement Microphones

by *Knud Rasmussen* *

Abstract

The sensitivity of condenser measurement microphones depends on the environmental conditions, i.e. static pressure, temperature and humidity, which affect the acoustic properties of the air enclosed between the diaphragm and the back electrode and in the cavity behind the back electrode. This paper presents normalized values of the complex static pressure and temperature coefficients for laboratory standard microphone Brüel & Kjær Types 4160 and 4180, for the old free-field microphone Type 4145 and for two of the most commonly used new measurement microphones of the Falcon series, Types 4191 and 4192.

Résumé

La sensibilité des microphones à condensateur varie avec les conditions de mesurage environnantes : la pression statique, la température et l'humidité relative. Ces variables influent sur les propriétés acoustiques de l'espace compris entre le diaphragme, l'électrode arrière, et la cavité située derrière celle-ci. Cet article présente les valeurs normalisées des coefficients de température et de pression statique associées aux Microphones standard de laboratoire 4160 et 4180, à l'ancien Microphone de champ libre 4145 et à deux des microphones de mesurage les plus couramment utilisés de la série Falcon, les modèles 4191 et 4192.

* Danish Primary Laboratory of Acoustics, DTU Branch, Department of Acoustic Technology, Danish Technical University

Zusammenfassung

Die Empfindlichkeit von Kondensator-Meßmikrofonen hängt von den Umgebungsbedingungen ab. Statischer Druck, Temperatur und Feuchte beeinflussen die akustischen Eigenschaften der Luft, die zwischen der Membran und der Gegenelektrode und im Hohlraum hinter der Gegenelektrode eingeschlossen ist. Dieser Artikel präsentiert normalisierte Werte für die komplexen Druck- und Temperaturkoeffizienten für die Labor-Normalmikrofone Typ 4160 und 4180, für das ältere Freifeld-Mikrofon Typ 4145 und für zwei der am meisten eingesetzten neuen Meßmikrofone der Falcon-Serie, Typ 4191 und 4192.

Introduction

For a conventional condenser microphone the enclosed air behind the diaphragm is an integral part of the microphone. Because the acoustic properties of the enclosed air depends on the environmental conditions, i.e. static pressure, temperature and humidity all such microphones will exhibit a sensitivity which depends on these factors. This effect cannot be avoided, only minimized through proper design of the microphones.

The standard IEC 61094-2 [1] gives general information about environmental effects on LS (laboratory standard) type microphones as well as some generalized graphs on the frequency dependence. The theoretical background is given in ref. [2], where a lumped parameter model is developed, separating the various elements, which contribute to the resulting response of the microphone. From the basic theory of condenser microphones it is found that the pressure response of the microphone is inversely proportional to the acoustical impedance of the microphone, which can be derived from the lumped parameter model.

The model discussed is not restricted to LS type microphones but can be applied to all microphones of the same basic construction. The model considers the relation between the acoustical impedance of the diaphragm itself, which can be considered independent of the environmental conditions and the acoustical impedance of the enclosed air, i.e the thin air film between the diaphragm and backplate, the holes in the backplate and the cavity behind the backplate all of which depend on one or more of the environmental variables. The resulting static pressure- and temperature coefficients for the microphones are then determined by the ratio of the acoustical impedances of the microphone, calculated from the model at reference environmental

conditions and when the static pressure, and temperature are changed by 1 kPa and 1 K respectively.

While the geometry of the interior microphone housing does not change for a given type of microphone, both the mass density (thickness) and mechanical tension of the diaphragm are subject to systematic and individual changes due to production tolerances and adjustments. Hence it is concluded in [2] that for a given type of microphone the static pressure and temperature coefficients can be expressed by a single function normalized with respect to resonance frequency of the microphone and low frequency value of the individual coefficient. Such normalized functions are given as Tables in ref.[2] for the complex static pressure and temperature coefficients for Brüel & Kjær Type 4160 and Type 4180 microphones. The measurements presented in [2] were performed in 1/3-octave steps only. These measurements have been repeated using a higher frequency resolution, which allows the coefficients to be expressed by a simple polynomial. In addition, other types of microphones have also been investigated.

Measurement Technique

The measurement method used for determining the static pressure and temperature coefficients is the same as used in ref.[2], i.e a complete reciprocity calibration in a short closed plane-wave coupler has been conducted in accordance with IEC 61094-2 [1]. The measurement setup is identical to the earlier setup except that the signal generator and the precision voltmeter were substituted by a Brüel & Kjær Audioanalyzer Type 2012. The measurements were performed by sweeping through the frequency range 200 Hz to 20 or 40 kHz in 1/12-octave steps in order to increase the frequency resolution. However, the major improvement arises from the very short measurement time, about 5 minutes, for the critical part viz. the measurement of the generated sound pressure. In particular for the temperature coefficient measurements, this method has resulted in much better repeatability and more consistent results.

The reciprocity calibrations were conducted at five static pressures in the range 90 kPa to 110 kPa in steps of 5 kPa and at four temperatures from 15°C to 30°C in steps of 5°C. The measurements were performed by placing the coupler and microphones in a pressure vessel and in a climatic chamber respectively, and the above mentioned coefficients then determined at each frequency by a conventional straight-line regression analysis of the calculated sensitivities.

Measurement Results

The measurements have been performed on a number of five different types of microphones shown in the Table.

Brüel & Kjær Microphone Type	4160	4145	4180	4191	4192
Number of microphones	18	6	30	6	9

As an example, Fig. 1 shows the measured modulus of the static pressure coefficient δ_p for the 18 Type 4160 microphones. In order to derive a single expression valid for this type of microphones, the results for each microphone are first normalized with the low-frequency value and next the frequency axis is normalized with the resonance frequency of the individual microphone. The result of such normalization for the very same measurements is shown in Fig. 2. Due to the high number of measurement frequencies a numerical smoothing can be performed followed by a polynomial approximation. It has turned out that a ninth-order polynomial gives an adequate approximation to the measurement results for all microphones.

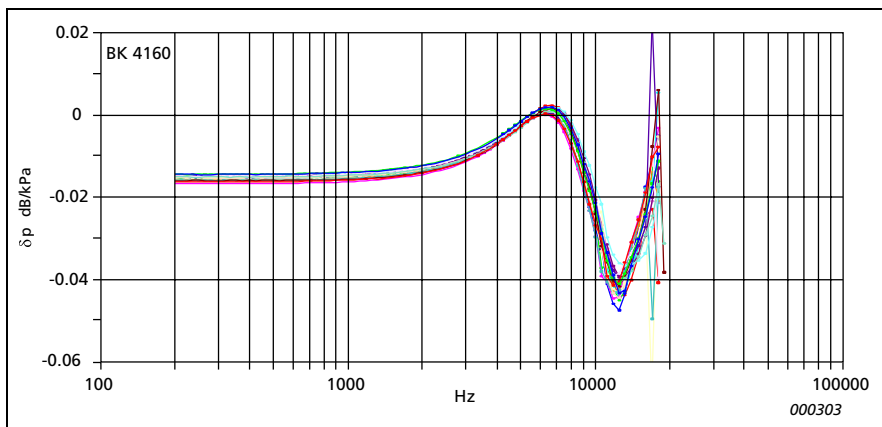

Fig. 1. Measured modulus of static pressure coefficient of 18 microphones Type Brüel & Kjær 4160

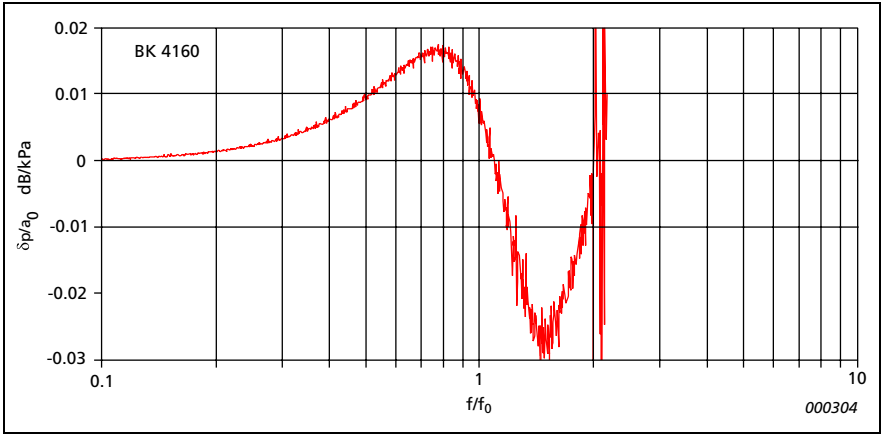

Fig. 2. Measured modulus of static pressure coefficient as shown in Fig. 1 but normalized with respect to resonance frequency and low-frequency value

This procedure has been applied to modulus and phase for both static pressure and temperature coefficients for all five type of microphones and the resulting polynomial constants $a_0 - a_9$ are given in Tables 1 and 2. The relevant coefficients δ_p and δ_t are then calculated from

$$\delta = a_0 + a_1 \cdot x + a_2 \cdot x^2 + \dots + a_9 \cdot x^9 \quad (1)$$

where $x = f/f_0$ is the frequency normalized by the resonance frequency of the individual microphone. The constant a_0 will be zero for the phase responses but represents the individual low-frequency value of the modulus of the relevant coefficient. In the tables the value of a_0 is given as the average value for the microphones used in the measurements but if available, individual values for the actual microphone should be used.

Constants	Type 4160		Type 4145		Type 4180		Type 4191		Type 4192	
	Modulus	Phase	Modulus	Phase	Modulus	Phase	Modulus	Phase	Modulus	Phase
a ₀	-0.0152	0	-0.0153	0	-0.00519	0	-0.0054	0	-0.0042	0
a ₁	-0.00584	0.0176	-0.0107	0.184	-0.0304	0.17	-0.0204	0.0274	-0.0104	0.0499
a ₂	0.132	0.924	0.428	1.527	0.5976	-2.267	1.469	3.16	0.308	-1.494
a ₃	-0.596	-6.14	-1.128	-21.76	-3.912	12.03	-8.27	-88.2	-2.029	12.74
a ₄	1.763	20.1	-0.329	81.26	14.139	-31.245	16.11	464.0	8.44	-55.56
a ₅	-2.491	-38.31	5.534	-160.52	-27.561	34.22	-17.17	-1212.5	-19.537	117.15
a ₆	1.581	40.26	-10.212	190.23	29.574	-11.936	21.22	1894	24.765	-137.12
a ₇	-0.358	-22.937	9.046	-135.88	-17.6325	-4.988	-29.97	-1808	-17.459	93.09
a ₈	-0.0364	6.665	-4.087	53.91	5.4997	4.632	23.62	969.7	6.4922	-34.45
a ₉	0.01894	-0.7758	0.756	-9.11	-0.7017	-0.912	-7.046	-222.5	-0.9987	5.359

Table 1. Polynomial constants for the complex static pressure coefficient δ_p

Constants	Type 4160		Type 4145		Type 4180		Type 4191		Type 4192 *)	
	Modulus	Phase	Modulus	Phase	Modulus	Phase	Modulus	Phase	Modulus	Phase
a ₀	-0.0020	0	-0.0034	0	-0.0012	0	-0.0032	0	-0.0053	0
a ₁	0.00913	-0.107	0.00513	-0.355	0.00633	-0.172	-0.00162	-0.374	0.00849	-0.0598
a ₂	-0.245	0.0283	-0.2835	1.805	-0.242	1.001	-0.423	0.91	-0.327	0.559
a ₃	1.673	1.248	0.367	-9.576	1.656	-5.10	-0.914	23.29	3.168	-4.92
a ₄	-6.058	-7.746	2.598	54.25	-6.1833	11.445	21.0	-124.7	-15.895	24.94
a ₅	11.766	20.725	-10.478	-166.55	11.81	-7.042	-70.78	282.9	43.32	-65.43
a ₆	-13.11	-26.957	17.557	276.69	-12.1366	-5.937	87.28	-366.5	-67.277	99.7
a ₇	8.5138	18.664	-15.654	-254.87	6.875	9.773	-6.41	293.3	59.788	-88.94
a ₈	-3.0016	-6.78	7.265	122.92	-2.0324	-4.547	-68.78	-137.46	-28.316	42.69
a ₉	0.4426	1.032	-1.3787	-24.233	0.2457	0.7284	39.49	28.68	5.535	-8.464

*) Valid only for the new improved version having serial numbers higher than 1933099

Table 2. Polynomial constants for the complex temperature coefficient δ_t

Due to the high order of the polynomial Eqn.(1), the calculations at high frequencies are quite sensitive to the constants and the values given in the tables should not be rounded or otherwise changed. Also the results are only valid in a limited frequency range which depends on the type of microphone. Table 3 gives the limitations on the usable frequency range for the coefficients which should not be exceeded.

Brüel & Kjær Microphone Type	4160	4145	4180	4191	4192
Static pressure coefficient δ_p	14	15	35	28	31.5
Temperature coefficient δ_t	14	15	35	28	28

Table 3. Maximum recommended frequency in kHz for using Tables 1 and 2

The normalized coefficients are shown in a graphical form in Figs.3–6. The general response is the same for the three pressure type microphones while the two free-field Types (4145 and 4191) are significantly different due to the much higher losses (3 times higher loss factor).

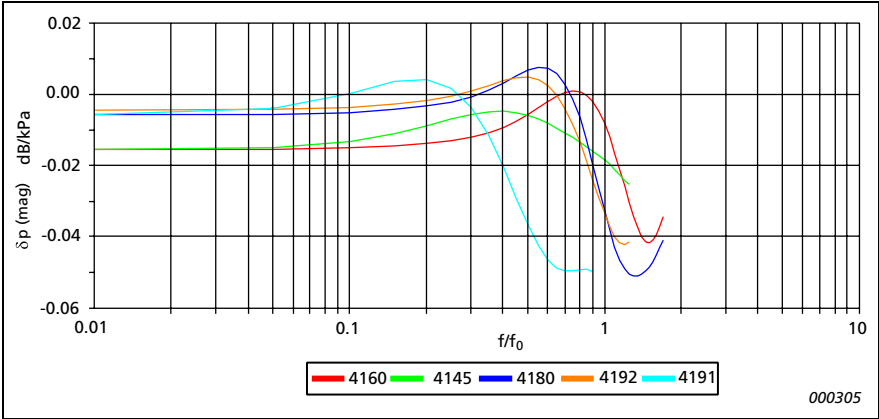

Fig. 3. Modulus of normalized static pressure coefficient in dB/kPa

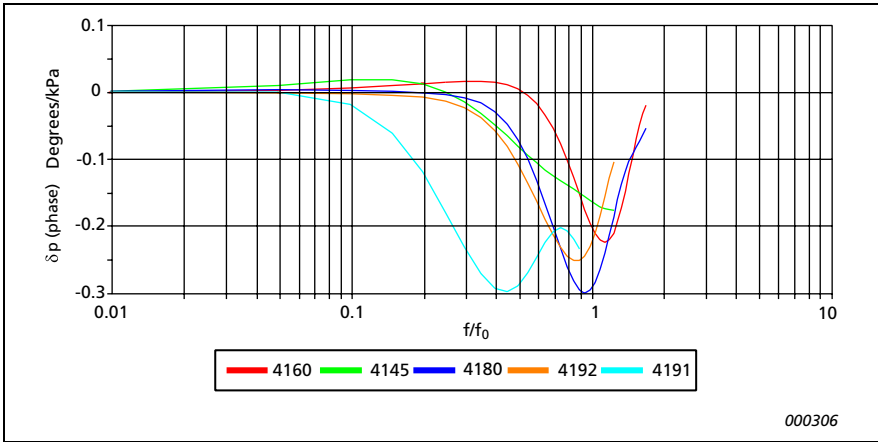

Fig. 4. Phase of normalized static pressure coefficient in degrees/kPa

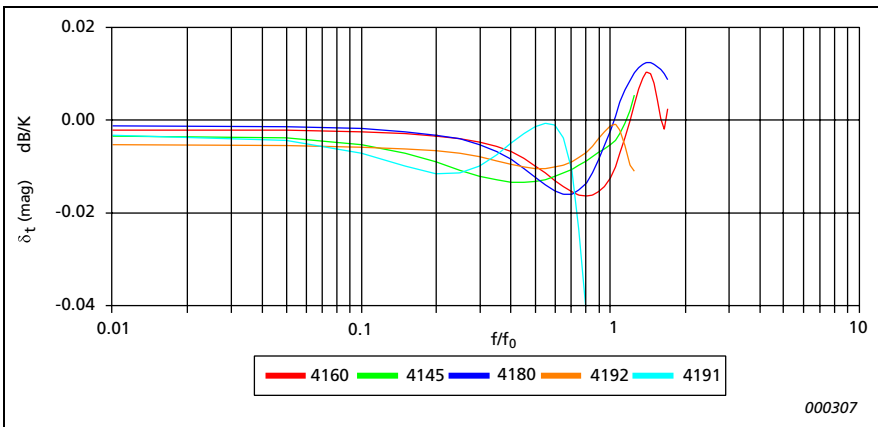

Fig. 5. Modulus of normalized temperature coefficient in dB/K

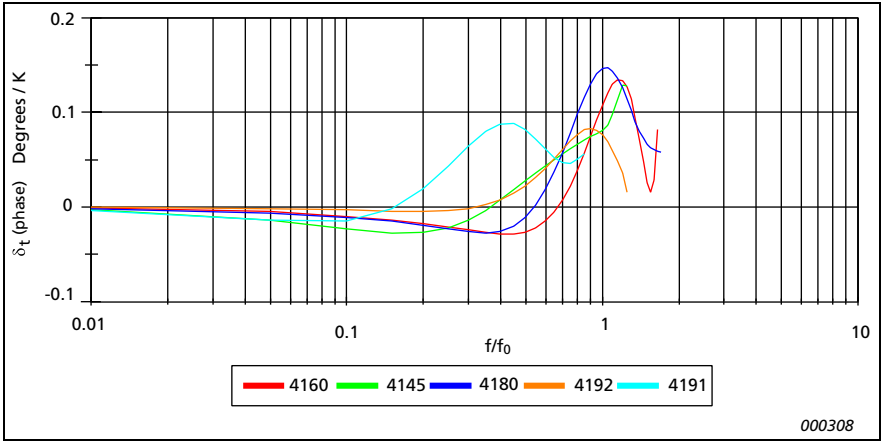

Fig. 6. Phase of normalized temperature coefficient in degrees/K

Practical Applications

When a microphone is used at a certain static pressure p_s and temperature t while the calibration values of the pressure sensitivity level $M_{p,ref}$ refer to other conditions, $p_{s,ref}$ and t_{ref} , the pressure sensitivity level M_p in dB re 1V/Pa at the actual conditions can be calculated from

$$M_p = M_{p,ref} + \delta_p(p_s - p_{s,ref}) + \delta_t(t - t_{ref}) \text{ dB re 1V/Pa} \quad (2)$$

where the coefficients δ_p and δ_t are calculated from Eqn.(1) and Tables 1 and 2.

In the absence of individual values for resonance frequency and low-frequency value of the coefficients of the microphones, Table 4 shows the average value for the microphones used in this investigation and the spread in the values expressed as twice the standard deviation. The repeatability of the measured low-frequency values of the environmental coefficients given in Table 4 is about 5% for the individual microphones, while the normalized response remains essentially the same. It should be recalled that the figures given for the WS-microphones (Types 4145, 4191 and 4192) are based upon a small number of specimens representing a limited period of production. Consequently the average values given may be slightly offset and the uncertainty

interval heavily underestimated. This will in particular be true for both average value and uncertainty interval for the temperature coefficient.

The low frequency value of the static pressure coefficient is determined by the ratio of the compliance of the back cavity and the total compliance of the microphone which is dominated by the diaphragm compliance. Consequently the low frequency value is a function of the microphone sensitivity.

Brüel & Kjær Microphone Type	4160	4145	4180	4191	4192
Resonance frequency kHz	8.41 ±0.52	11.96 ±1.10	22.34 ±1.68	35.17 ±1.97	24.22 ±2.20
Low frequency static pressure coefficient δ_p dB/kPa	-0.0152 ±0.0014	-0.0153 ±0.0011	-0.0052 ±0.0012	-0.0054 ±0.0015	-0.0042 ±0.0014
Low frequency temperature coefficient δ_t dB/K	-0.0020 ±0.0016	-0.0034 ±0.0004	-0.0012 ±0.0023	-0.0032 ±0.0018	-0.0053 ^{*)} ±0.0054

*) Valid only for the improved version having serial numbers higher than 1933099

Table 4. Average values of resonance frequency, static pressure and temperature coefficients for the investigated microphones

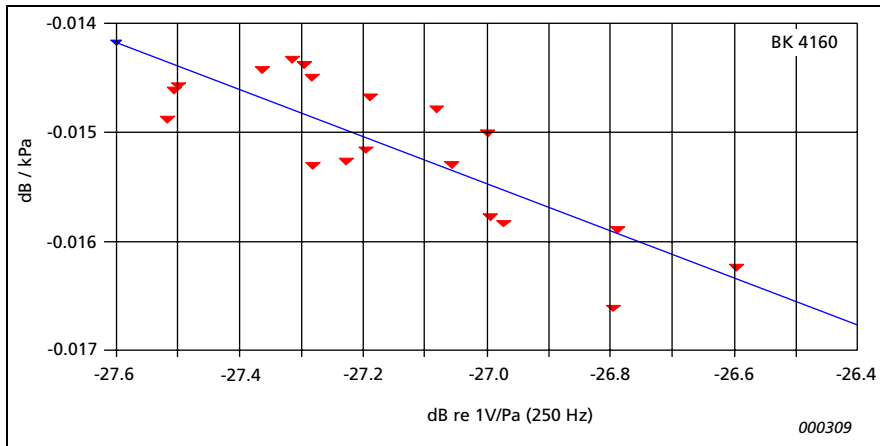

Fig. 7. Low frequency value a_0 of static pressure coefficient δ_p as function of the pressure sensitivity level at 250 Hz for 18 microphones Brüel & Kjær Type 4160

Figs. 7 and 8 show the relations between the measured low-frequency value of the static pressure coefficients, i.e. the constants a_0 for the static pressure coefficients and the microphone sensitivity level $M_{p,250\text{ Hz}}$ at 250 Hz in dB re 1 V/Pa for the Brüel & Kjær microphone Types 4160 and 4180 used in this investigation.

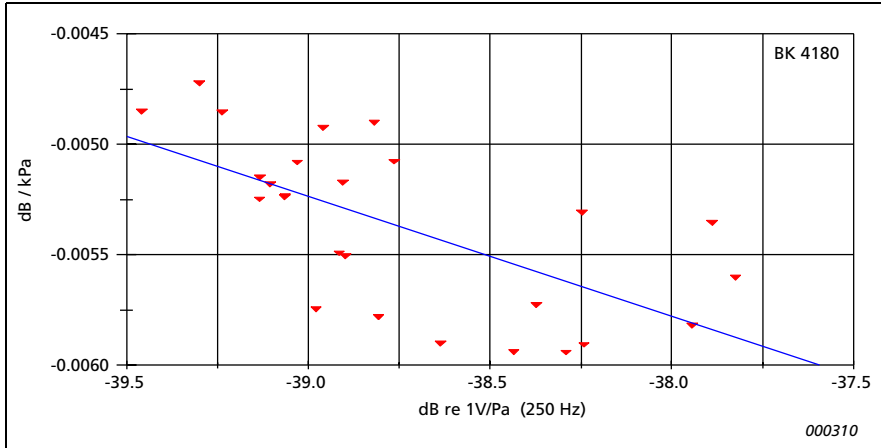

Fig. 8. Low frequency value a_0 of static pressure coefficient δ_p as function of the pressure sensitivity level at 250 Hz for 30 Brüel & Kjær microphones Type 4180

The linear regression line shown on the graphs is given by

$$\delta_p = -0.0739 - 2.164 \cdot 10^{-3} \cdot M_{p,250\text{ Hz}} \text{ dB/kPa for Brüel \& Kjær Type 4160} \quad (3)$$

$$\text{and } \delta_p = -0.02642 - 543 \cdot 10^{-6} \cdot M_{p,250\text{ Hz}} \text{ dB/kPa for Brüel \& Kjær Type 4180} \quad (4)$$

with an expanded uncertainty ($k = 2$) of 0,0005 dB/kPa. These figures deviate slightly from the values reported in ref. [2] mainly due to the larger number of microphones involved.

A similar relation does not exist for the low frequency value of the temperature coefficients as this value is determined solely by the mechanical construction. The resonance frequency of the microphones too cannot be predicted from the pressure sensitivity but has to be determined by other means, such as through measurement of the phase response of the microphone.

Uncertainty Estimation

The resulting uncertainty when correcting calibration results to reference environmental conditions and/or deriving the sensitivities at environmental conditions different from those valid for the calibration data, is determined by the uncertainty of the individual low frequency value of the above-mentioned coefficients and resonance frequency of the microphones. Table 4 gives an estimate on the uncertainty of the low-frequency value of the coefficients when typical values are applied. For the static pressure coefficient of LS-microphones a lower uncertainty can be obtained by using the relations given in Eqns.(3–4).

However, at high frequencies the major contribution arises from the uncertainty on the resonance frequency because the slope of all the coefficients has a maximum around that frequency. If the average values shown in Table 4 are used for the resonance frequency, the spread in the values also given in Table 4 may be used to estimate the uncertainty of the coefficients.

Additional Remarks

The static pressure only affects the acoustical properties of the enclosed air and not the properties of the diaphragm. This is why the static pressure coefficient can be derived by Eqns. 3 and 4 with a fairly low uncertainty.

However, the temperature affects both the acoustical properties of the enclosed air and the behaviour of the diaphragm due to small dimensional changes in the microphone. The dimensional changes may result in two effects, viz a resulting change in diaphragm tension and a change in the distance between diaphragm and back-electrode. Both effects will change the sensitivity but a change of the diaphragm tension will be at minimum at the resonance frequency of the microphone. In an optimal design the two effects are balanced to give a minimum effect on the sensitivity at low frequencies. The major influence is caused by the air properties which results in the large values of the temperature coefficient at high frequencies, see Figs. 5–6.

The influence of humidity has not been discussed up to now. It is but fairly easy to see that humidity affects the acoustic properties of the enclosed air in the very same way as temperature, and that about 30% change in the relative humidity results in the same changes as 1 degree Celcius. It has therefore not been possible up to now to demonstrate any effect of humidity on the sensitivity of the microphones used in this investigation. Humidity will not affect the mechanical part of the microphone either as long as condensa-

tion is not present. However, it is possible that the electrical insulation between diaphragm and backplate may be affected by humidity. If so the microphone will exhibit an increased noise level and instability, but probably not a reversible dependence of humidity. The isolators used in the tested types of microphones are not hygroscopic and only excessive dirt on the isolator may result in a dependence of humidity.

Conclusion

Measurement results are presented showing the influence of static pressure and temperature as function of frequency on the pressure sensitivity of specific type of microphones, arising mainly from changes in the acoustical properties of the air enclosed behind the diaphragm.

The determination of the coefficients are based on measurements performed in the intervals 90–110 kPa and 15–30°C without observing any sign of non-linearity. Thus it is estimated that Eqn. 2 and the figures given in Tables 1 and 2 are valid in the ranges of static pressures 70–120 kPa and temperatures 0–40°C without affecting the stated uncertainty significantly.

References

- [1] IEC Publication 61094–2, 1992: *“Measurement microphones – Part 2 – Primary method for pressure calibration of laboratory standard microphones by the reciprocity technique”*
- [2] Rasmussen, K., *“The static pressure and temperature coefficients of laboratory standard microphones”*, Metrologia, 36, pp.265 – 273, 1999

Reduction of Heat Conduction Error in Microphone Pressure Reciprocity Calibration

by Erling Frederiksen

Abstract

The microphone reciprocity calibration method, which is used for absolute determination of the sound pressure unit (Pa), is highly refined today. Thus phenomena having hitherto only minor influence on the calibration results have today become of greater interest. One such phenomenon is related to non-regular surface elements of the cavity in front of the diaphragm of the calibrated standard microphones. These surface elements cause additional heat-conduction effects, which need to be taken into account in high precision calibrations. This effect, which is generally ignored, even by highly elaborated sensitivity calibration programs, may cause significant errors, especially at low frequencies. Examples of errors are calculated and shown for commonly applied types of microphone and calibration coupler.

Résumé

La méthode d'étalonnage des microphones par réciprocity, utilisée pour déterminer de manière absolue l'unité de pression acoustique (Pa), a été grandement corrigée et affinée au fil des années. Par voie de conséquence, des phénomènes qui n'influaient pratiquement pas jusque là sur les résultats de l'étalonnage retiennent aujourd'hui l'intérêt. Un de ces phénomènes est lié à l'irrégularité de surface des éléments de la cavité située devant le diaphragme des microphones standard étalonnés. Ces éléments induisent un effet de conduction thermique qui doit être pris en compte pour les étalonnages de haute précision. Cet effet, généralement ignorés par les programmes avancés d'étalonnage en sensibilité, peut être cause d'erreurs, notamment aux basses fréquences. Des exemples de calculs erronés sont ici présentés pour des types de microphones et de coupleurs d'étalonnage courants.

Zusammenfassung

Die Mikrofonkalibrierung nach dem Reziprozitätsverfahren, das zur absoluten Bestimmung des Schalldrucknormals (Pa) verwendet wird, ist heute stark verfeinert. Deshalb haben Phänomene, die bisher nur geringen Einfluß auf die Kalibrierergebnisse hatten, an Interesse gewonnen. Eines dieser Phänomene hängt mit nichtregulären Elementen an der Hohlraumoberfläche vor der Membran kalibrierter Normalmikrofone zusammen. Diese Oberflächenelemente verursachen zusätzliche Wärmeleitungseffekte, die bei hochpräzisen Kalibrierungen berücksichtigt werden müssen. Dieser Effekt, der in der Regel ignoriert wird - selbst bei sehr anspruchsvollen Kalibrierprogrammen - kann bedeutende Fehler verursachen, insbesondere bei tiefen Frequenzen. Es werden Beispiele für Fehler mit gebräuchlichen Mikrofontypen und Kalibrierkupplern berechnet und gezeigt.

Introduction

The sound pressure unit (Pascal) today is determined by calibrating Laboratory Standard Microphones using the pressure reciprocity calibration technique. This absolute calibration method was invented in the forties by National Bureau of Standards in USA. Since then the method has been carefully analysed and highly refined. Therefore, the calibration uncertainty of internationally leading calibration laboratories is now as low as 0,025 dB ($k=2$) from say 100 Hz to 5 kHz or to 10 kHz depending on the size and type of microphone. A consequence of this is that physical phenomena, which have relatively small influence on the calibration and were previously ignored, have now become of interest for national and other high-level calibration laboratories. Such a phenomenon is described below. It is related to heat conduction that occurs at surfaces of the front cavities of standardised one-inch Laboratory Standard Microphones, such as Brüel & Kjær Types 4160, 4144 and 4145.

Reciprocity Calibration

Microphone reciprocity calibration is generally performed with three microphones (A, B and C) which are acoustically coupled together two by two (AB, AC and BC); see the international standard IEC 61094-2. One of the two microphones is driven as a sound source, while the other one receives the generated sound. The coupling is made by a gas (usually air), which is

enclosed in a small cavity formed by the coupler and the two microphones. For each pair of microphones both the electrical and the acoustic transfer impedances are determined. The electrical impedance is measured, while the acoustic impedances is calculated from the gas properties, the cavity dimensions and the impedance of the microphones.

According to the IEC standard the acoustic transfer impedance is calculated by considering a pure adiabatic compression process in the coupler and by applying a correction factor for the deviation from this ideal situation. The deviation is caused by heat conduction between the gas and the walls of the cavity. The heat conduction correction is a complex factor and a function of the type of gas (ratio of specific heats) and frequency. The correction increases with decreasing frequency and with increasing ratio between the cavity surface area and the volume of the coupler; see IEC 61094-2, Annex A.

When the electrical and acoustic impedance parameters are measured and calculated, the pressure sensitivities can be worked out for all three microphones. The formulae below are examples, which define the sensitivity of microphone 'A' and the acoustic transfer impedance of the coupler with the microphones 'A' and 'B' inserted:

$$M_{p,A} = \sqrt{\frac{Z_{e,AB} \cdot Z_{e,AC}}{Z_{e,BC}} \cdot \frac{Z_{a,BC}}{Z_{a,AB} \cdot Z_{a,AC}}}$$

$$\frac{1}{Z_{a,AB}} = \left(\frac{1}{Z_{a,A}} + \frac{1}{Z_{a,B}} \right) \cosh(\gamma \cdot l_{AB}) + \left(\frac{S_{AB} \cdot \Delta_{H,AB}}{\sigma \cdot c} + \frac{\sigma \cdot c}{S_{AB} \cdot \Delta_{H,AB}} \cdot \frac{1}{Z_{a,A} \cdot Z_{a,B}} \right) \sinh(\gamma \cdot l_{AB})$$

where

$M_{p,A}$	Pressure Sensitivity of Microphone 'A'
$Z_{e,AB}, Z_{e,AC}, Z_{e,BC}$	Electrical Transfer Impedance with microphones 'A', 'B' and 'C' respectively
$Z_{a,AB}, Z_{a,AC}, Z_{a,BC}$	Acoustic Transfer Impedance with microphones 'A', 'B' and 'C' respectively
$Z_{a,A}, Z_{a,B}$	Acoustic Diaphragm Impedance of microphones 'A' and 'B'
γ	Complex sound propagation coefficient ($\gamma = \alpha + j\beta$)
l_{AB}	Length of cavity with microphones 'A' and 'B'

S_{AB}	Mean cross-sectional area of cavity with microphones 'A' and 'B'
ρ	Density of enclosed gas
c	Speed of sound in enclosed gas
$\Delta_{H,AB}$	Heat conduction correction for the cavity with microphones 'A' and 'B'

According to IEC 61094-2 standard the heat-conduction correction can be applied either to the volume or to the cross-sectional area of the cavity. In the expression above, which accounts for axial wave-motion and leads to the lowest calibration uncertainty, the correction is applied to the cross-sectional area.

Calculation of the heat conduction correction and the underlying theory is quite complex. The subject is described in Annex A of the IEC standard and by H. Gerber in an article of the Journal of the Acoustical Society of America (JASA, Vol. 36, 1964).

Microphone Front Cavities

The cavity between the front surface and the diaphragm of a Laboratory Standard Microphone is called the front cavity. The two front cavities of a pair of microphones contribute to the surface area and to the volume of that cavity, which during the pressure reciprocity calibration couples the microphones together. Ideally these front cavities should be cylindrical. However, the presently available types of one-inch Laboratory Standard Microphone (IEC 61094-1, LS1p and LS1f) do have a thread for mounting a diaphragm protection grid. This thread increases the cavity surface area significantly; see Fig. 1. The surface area of the thread, which has flanks of 60°, is twice as large as that of a cylindrical surface, which encloses the same volume of air. For Type 4160 the threaded length is 1,4 mm, which leads to an additional surface area of 80,5 mm²; see Fig. 1.

When used for reciprocity calibration the microphones Type 4144 and Type 4145 are equipped with an Adapter Ring (DB 0111), which forms the front cavity required by the IEC 61094-1 standard. This ring has a thread and, therefore, an extra surface area, which is identical to that of Type 4160. However, the adapter ring and the microphone do also form a narrow ring-shaped cavity along the edge of the active part of the diaphragm. Both surface and volume of this cavity contribute significantly to the overall area and volume of the cavity, which couples the microphones together; see Fig. 2. The volume of the ring-shaped cavity is approx. 35 mm³, while its area is 250 mm².

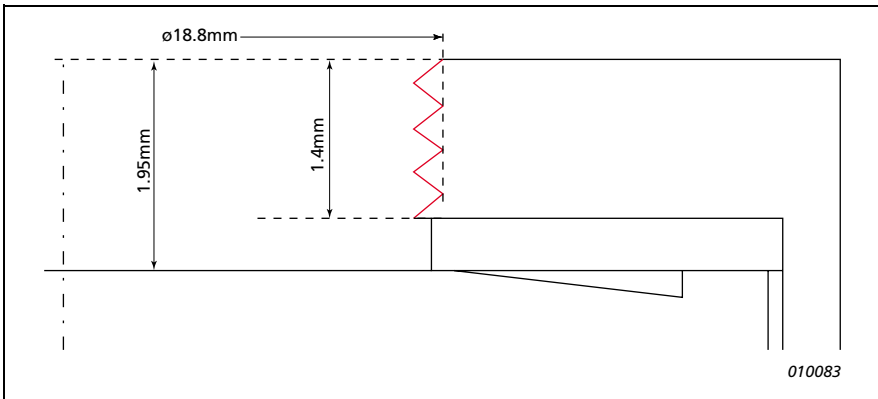

Fig. 1. Front cavity of the Brüel & Kjær Laboratory Standard Microphone Type 4160. The thread makes the surface area twice as large as that of a corresponding cylindrical surface

The volume and extra surface areas influence the calibration results. The influence of the latter is caused by the effect of heat-conduction.

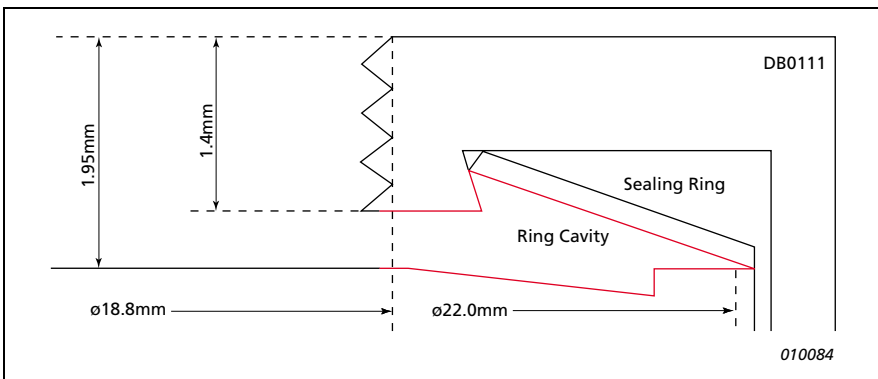

Fig. 2. Front Cavity of Brüel & Kjær Microphones Types 4144/45 equipped with Adapter Ring (DB0111). Thread and ring-shaped cavity increase front cavity area and volume significantly

Influence of Heat Conduction on Calibration Results

The influence of heat conduction depends on the ratio of surface area and volume of the applied coupler and microphones. Basically there are two types of coupler, which are generally called Large Volume and Plane Wave Couplers. Today Large Volume Couplers are less frequently used. Most internationally leading calibration laboratories have replaced them by two or more Plane Wave Couplers with internal diameter identical to that of the diaphragm of the calibrated microphones. These couplers act as essentially ideal acoustic transmission lines and are treated accordingly, which means that they cover a much wider frequency range than the large couplers. On the other hand their smaller volume implies a higher ratio between surface area and volume, which makes them more sensitive to the effect of heat-conduction that occur between the enclosed gas and the surfaces of the cavity.

The plane wave couplers are also more sensitive to the equivalent volume or impedance of the calibrated microphones, which varies between units of any certain type of microphone. However, today the influence of such variations is (or may be) minimized by calibrating with two or more different couplers and by using a data fitting method for the microphone parameters. The fitting method is based on the logical assumption that the results of reciprocity calibrations should not depend on the size or length of the applied coupler.

Therefore, the value, which gives identical results with the different couplers, is taken as the correct value.

Accredited calibrations of one-inch microphones, which are performed by the Danish Primary Laboratory of Acoustics (DPLA), are made with two couplers of lengths 7,5 mm and 15,0 mm respectively; see Fig. 3 and Table 1 for further dimensions. As the Brüel & Kjær Reciprocity Calibration System and several other calibration laboratories use couplers of the same dimensions, these couplers were taken as examples for demonstrating the influence of the microphone thread and the ring shaped cavity.

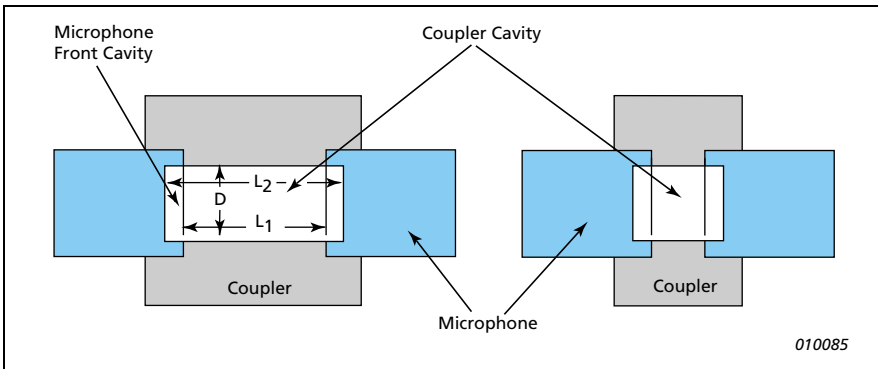

Fig. 3. Sketches of long and short Plane Wave Couplers used by many calibration laboratories. Dimensions are given in Table 1

DPLA and Type 9699 Couplers	Diameter (D)	Length (L ₁) without Microphones	Length (L ₂) with Microphones
Long Coupler Cavity	18,6 mm	15,0 mm	18,9 mm
Short Coupler Cavity	18,6 mm	7,5 mm	11,4 mm

Table 1. Coupler dimensions

Microphones	Additional Volume	Additional Surface Area
Type 4160	none	81 mm ²
Types 4144/45	35 mm ³	331 mm ²

Table 2. Additional ring-cavity volume and surface area of microphones

Volume and surface area of the ring-shaped cavity and of the additional surface area of thread are given in Table 2 for the Brüel & Kjær microphones Types 4160, 4144 and 4145. These microphones are commonly calibrated by the pressure reciprocity method and applied as national standards. The

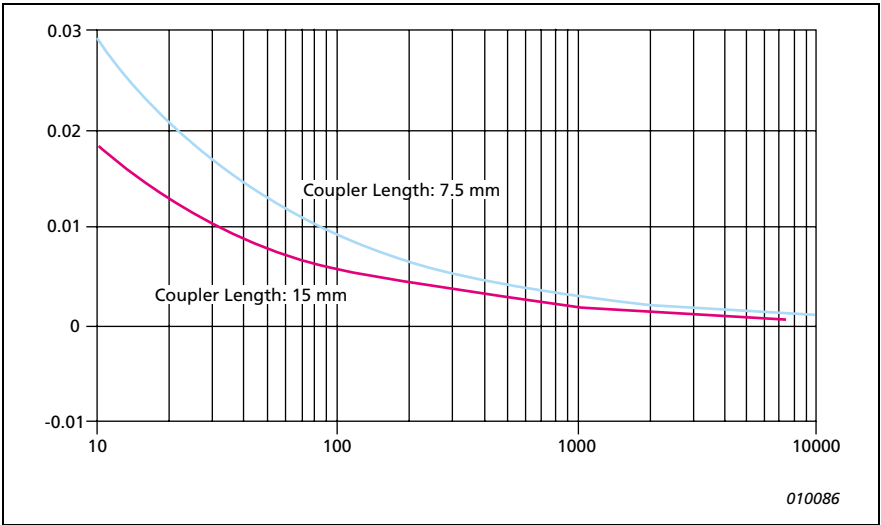

Fig. 4. Increase in heat-conduction corrections for microphone Type 4160. Valid for calibrations made with Plane Wave Couplers of 7,5 mm and 15,0 mm length

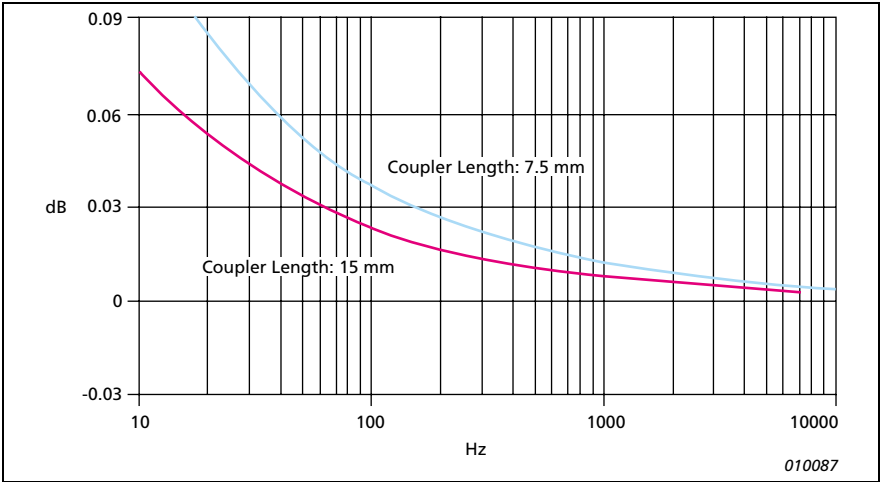

Fig. 5. Increase in heat-conduction corrections for microphones Type 4144 and Type 4145. Valid for calibrations made with Plane Wave Couplers of 7,5 mm and 15,0 mm length

influence of the listed microphone parameters has been calculated for the couplers described above. The calculations of transfer impedance and microphone sensitivity are made in accordance with IEC 61094-2 by a program written in Mathcad from MathSoft, Inc. This specific program was chosen, because the program (MP.exe from the Danish Technical University), which is generally used by DPLA, considers cylindrical microphone front cavities and cannot account for the larger surface areas.

The influence of the additional surfaces, which is calculated for different combinations of microphones and couplers, are shown in Figs. 4 and 5. It is presented as the increase in heat-conduction correction caused by the surfaces of the thread and the ring-cavity. Note the different resolutions used on the scales of the graphs.

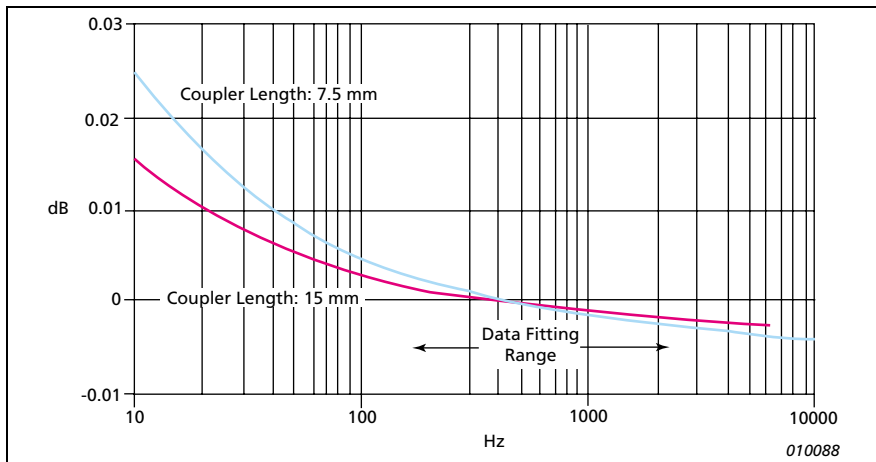

Fig. 6. Additional heat-conduction corrections for microphone Type 4160. The curves are valid for calibrations made with Plane Wave Couplers of 7,5 mm and 15 mm length, when the equivalent volume of the microphone diaphragm is fitted based on sensitivity results obtained over the range from 125 Hz to 2000 Hz

If the data fitting method is applied for microphone diaphragm equivalent volume, the influence of the additional front cavity surfaces is reduced. This is especially the case within the frequency range of the fitting itself. DPLA optimizes the accuracy at the important calibrator frequencies 250 Hz and 1000 Hz

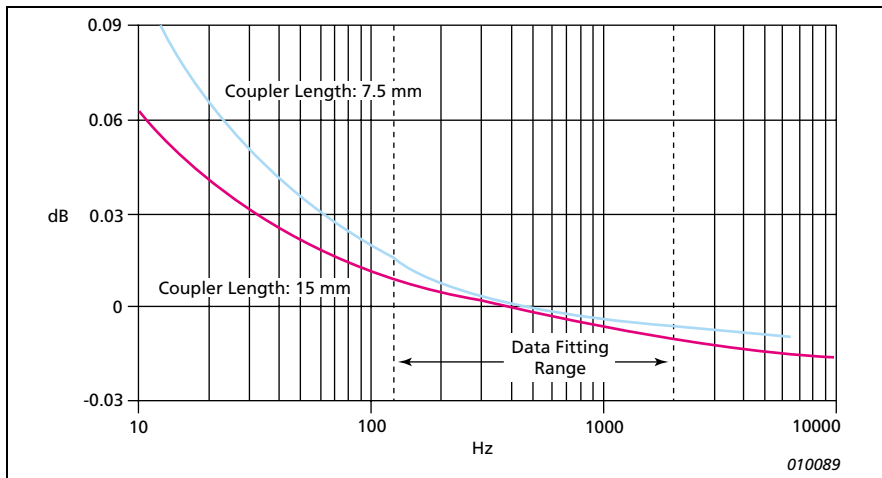

Fig. 7. Additional heat-conduction corrections for microphones Type 4144 and Type 4145. The curves are valid for calibrations made with Plane Wave Couplers of 7,5 mm and 15,0 mm length, when the equivalent volume of the microphone diaphragm is fitted based on sensitivity results obtained over the range from 125 Hz to 2000 Hz

by fitting the equivalent volume over the range 125 Hz to 2000 Hz. This means that the corrections shown in Fig. 6 and Fig. 7 should be applied with the present versions of the Sensitivity Calculation Program MP.exe, which do not account for the heat-conduction of the additional front cavity surfaces.

Conclusion

Non-regular and non-desired surface areas related to the front cavity of the presently available types of Laboratory Standard Microphone (IEC 61094-1, LS1p and LS1f) have significant influence on the sensitivity determined by the pressure reciprocity calibration methods described in IEC61094-2 and in other standards. Therefore, these additional surface areas must always be taken into account, when low calibration uncertainty is required. Proper attention to the surfaces and the related heat-conduction eliminates significant systematic calibration errors. These errors, which decrease with frequency may be as large as -0.08 dB at 20 Hz and -0.02 dB at 250 Hz depending on the types of microphone and coupler applied for the calibration.

Frequency Response for Measurement Microphones – a Question of Confidence ^{*}

by Johan Gramtorp and Erling Frederiksen

Summary

For many applications it is important to know the frequency response of the measurement microphone. There are a number of methods available for determination of the frequency response of a microphone. Some of the methods are described in IEC standards as 61094–2 and 61094–3. For the special Laboratory Standard microphones as LS1P and LS2P (described in IEC 61094–1) it is possible to have a primary calibration at a national calibration laboratory. Most of the other measurement microphones are normally calibrated using the electrostatic actuator calibration method. The actuator response is measured and the free-field correction supplied by the microphone manufacturer is added. From most manufacturers no information about the uncertainty on the determination of the actuator response and the free-field corrections has been available. A complete set of uncertainty values for actuator responses and free-field corrections for the new Brüel & Kjær Falcon Range microphones will be presented and discussed.

Résumé

Dans le cadre de nombreuses applications, il est essentiel de connaître la réponse en fréquence du microphone de mesure. Pour déterminer ce paramètre, plusieurs méthodes sont utilisables, et certaines sont décrites dans des textes normatifs tels que CEI 61094–2 et 61094–3. En ce qui concerne les microphones standard de laboratoire LS1P et LS2P (décrits dans la CEI 61094–1), un étalonnage primaire est possible auprès d'un centre d'étalonnage au niveau national. La plupart des autres microphones de mesure sont généralement étalonnés au moyen d'une méthode par excitation électrostatique. A la réponse mesurée de l'excitateur sont ajoutées les

* First presented at ASA Conference in December 1996

termes correctifs de champ libre fournis par le fabricant. Or, la plupart des fabricants n'informent ni sur l'incertitude de détermination de la réponse de l'excitateur ni sur les corrections de champ libre. Un jeu complet de valeurs relatives à ces deux paramètres est ici présenté et discuté pour les nouveaux microphones de la gamme Falcon de Brüel & Kjær.

Zusammenfassung

Bei vielen Anwendungen ist es wichtig, den Frequenzgang des Meßmikrofons zu kennen. Der Frequenzgang eines Mikrofons läßt sich mit Hilfe verschiedener Verfahren bestimmen. Einige der Verfahren sind in Normen wie IEC 61094 –2 und IEC 61094 –3 beschrieben. Für spezielle Labor-Normalmikrofone wie LS1P und LS2P (beschrieben in IEC 61094 –1) ist es möglich, eine Primärkalibrierung bei einem nationalen Kalibrierlaboratorium durchzuführen. Die meisten anderen Meßmikrofone werden normalerweise mit einem elektrostatischen Kalibriergitter kalibriert. Zu dem mit dem Kalibriergitter aufgenommenen Frequenzgang werden die vom Mikrofonhersteller angegebenen Freifeldkorrekturen addiert. Die meisten Hersteller machen keine Angaben über die Meßunsicherheit bei der Frequenzgangermittlung mit Kalibriergitter und Bestimmung der Freifeldkorrektur. Es wird ein kompletter Datensatz mit Meßunsicherheiten für Frequenzgänge mit Kalibriergitter und Freifeldkorrekturen für die neuen Brüel & Kjær-Mikrofone der Falcon-Serie vorgestellt und diskutiert.

Introduction

In an earlier article, ref. [1] Erling Frederiksen, Johan Gramtorp, "Measurement of Microphone Free-field Corrections and Determination of their Uncertainties" the determination of the free-field correction (without protection grid) for a Brüel & Kjær Type 4191 microphone was described.

This article covers all the new Brüel & Kjær Falcon Range microphones, and the influence of the protection grid and the electrostatic actuator calibration is described. This leads to uncertainty values for the resulting individual free-field response calibration (0° incidence).

Description of Free-field Corrections

The free-field correction is the ratio between the free-field response and the response of the microphone diaphragm system. The correction is dominantly

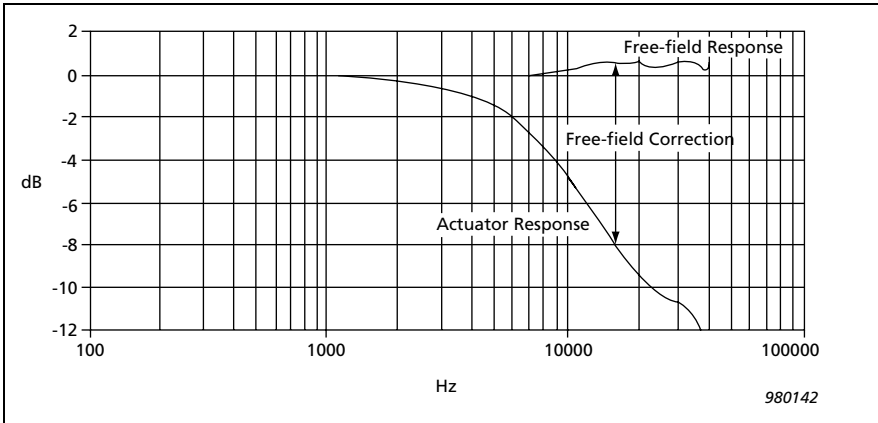

Fig. 1. Free-field Frequency Response of a Brüel & Kjær Type 4191 microphone obtained by adding the free-field correction to an individually measured Actuator Response

determined by sound reflection and refraction caused by the microphone body. Actually there are two different types of free-field corrections. They refer to the slightly different pressure-field and electrostatic actuator responses. Both responses account for the individual properties of the microphone diaphragm system. The free-field corrections mentioned in this paper all refer to the electrostatic actuator response, Fig. 1. The frequency response calibrations based on measurement of the individual electrostatic actuator response are especially simple and require no special acoustic facilities.

Determination of Free-field Corrections

The determination of the type specific free-field correction for a microphone with protection grid includes the following:

- 1) Free-field response measurement
- 2) Electrostatic actuator response measurement
- 3) Determination of free-field correction without protection grid
- 4) Protection grid correction measurement

Free-field Response Measurement

The free-field response were measured using the free-field reciprocity technique described in the international standard IEC 61094 –3.

Three microphones were calibrated together. Pairwise they were mounted in an anechoic room where one was transmitting sound to the other. Microphone (a) transmitted to receiver (b), (b) to (c), and (c) to (a).

The sensitivity products can be expressed by the following formula (as described in Ref. [1]):

$$M_{f,a} \cdot M_{f,b} = - \frac{U_{R,b}}{U_{T,a}} \cdot \frac{d_{ab}}{\rho \cdot \pi \cdot f^2 \cdot C_a} \cdot e^{\alpha d_{ab}}$$

$U_{R,b}$: Receiver output voltage

f : Frequency

ρ : Air density

$U_{T,a}$: Transmitter driving voltage

C_a : Transmitter Capacitance

α : Sound attenuation of air

d_{ab} : Distance between acoustic centres of the microphones

For all three pairs of microphone the output voltage of the receiver microphone, the voltage driving the transmitter and the transmitter capacitance were measured. During the measurement of the receiver voltage, the voltage across the transmitter was kept constant as a function of frequency.

After determination of the above parameters for the three pairs of microphones the individual free-field sensitivity module were calculated using the formula below.

$$M_{f,a} = \left(\frac{U_{R,a} \cdot U_{R,c}}{U_{R,b}} \cdot \frac{U_{T,b}}{U_{T,a} \cdot U_{T,c}} \cdot \frac{d_{ab} \cdot d_{ca}}{d_{bc}} \cdot \frac{C_b}{C_a \cdot C_c} \cdot \frac{1}{\rho \cdot \pi \cdot f^2} \cdot e^{\alpha(d_{ab} - d_{bc} + d_{ca})} \right)^{\frac{1}{2}}$$

The resulting uncertainty of the 0°-incidence free-field response was estimated from the uncertainty of the parameters applied for its calculation. Their uncertainties were separated into groups of random and systematic errors as their weight in the reciprocity calculations are different. The sys-

tematic errors do partly eliminate each other while the non correlated or random errors add up statistically. The relative uncertainty of free-field response was determined by using the formula below:

$$\frac{\Delta M_f}{M_f} = A \times \left(\left(\frac{\Delta U_R}{U_R} \right)^2 + \left(\frac{\Delta U_T}{U_T} \right)^2 + \left(\frac{\Delta C}{C} \right)^2 + \left(\frac{\Delta f^2}{f^2} \right)^2 + \left(\frac{\Delta d}{d} \right)^2 + \left(\frac{\Delta \rho}{\rho} \right)^2 + \left(\alpha d \frac{\Delta \alpha}{\alpha} \right)^2 + \left(\alpha d \frac{\Delta d}{d} \right)^2 \right)^{\frac{1}{2}}$$

where the weighting factor “A” equals 1/2 for the systematic and $\sqrt{3}/2$ for the random uncertainties respectively.

As can be seen from the formula there are a lot of sources adding to the uncertainty of the free-field response. Some of the systematic errors cancel out during the reciprocity calculation ($\Delta U_R/U_R$ and $\Delta U_T/U_T$). The dominant uncertainties ends up being the systematic uncertainties in the measurement of transmitter capacitance and distance between the acoustic centres of the microphones.

Electrostatic Actuator Response Measurement

The actuator responses were measured with the 0.01 dB resolution and with the same measurement system as that used for the free-field measurements. This type of measurement is relatively easy to perform.

The response measured with an electrostatic actuator is generally influenced by the radiation impedance which loads the microphone diaphragm. This influence is dependent of the diaphragm impedance of the microphone (smallest for microphones with the highest diaphragm impedance). The influence is for all the microphones less than 0.3 dB below 10 kHz and ranges to about 0.3 dB at 40 kHz for Type 4191 and 2.0 dB at 20 kHz for Type 4189/90. As the influence may be modified by the mechanical configuration of the actuator, the actuator type used for calibration service should be equal to that used for determination of the free-field corrections.

The actuator response is measured with the same measuring system as the free-field response. Combined with long measuring times, and correction for frequency response for the total measurement system, this leads to lower uncertainty values than normally achieved for electrostatic actuator measurements. Typical U_{95} values of 0.072 dB at 20 kHz and 0.132 dB at 40 kHz.

Determination of Free-field Correction without Protection Grid

The absolute sensitivity cannot be measured accurately with an electrostatic actuator. Therefore, there is no reason for also spending great efforts on obtaining an absolute measurement of the free-field response. The division of the free-field response by the actuator response will, anyway, give a result which contains a significant error. However, as this error makes a constant factor over the entire frequency range, some methods are available for its elimination.

To verify the measured free-field correction results the microphone and the sound field were simulated by a mathematical model. Simulation of the free-field corrections have been made for very detailed models of all the Brüel & Kjær Falcon Range microphones by the Boundary Element Method. The simulation accounted for the microphone dimensions, the diaphragm impedance and the properties of the ambient air. These simulations were based on the principles described in ref. [4] Peter Juhl, "Numerical Investigation of Standard Condenser Microphones". This method has proved to be very accurate at frequencies below the diaphragm resonance frequency. The 1/3 octave calculation results are shown by the points in Fig.2.

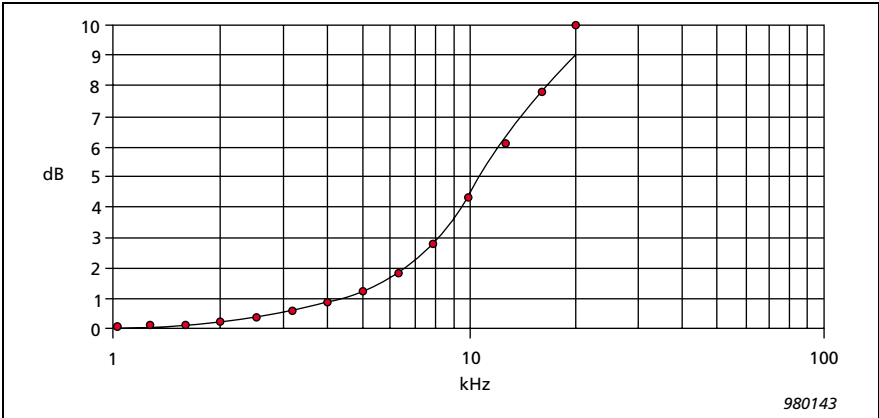

Fig. 2. Measured (curve) and calculated (points) free-field corrections for Type 4190 (0° incidence). The results are valid without protection grid

The resulting free-field correction may thus be determined by Boundary Element Method below 1 kHz. At frequencies above 1 kHz the measured free-field correction (free-field response divided by the electrostatic actuator response) was adjusted by multiplying a constant to give the best fit to the calculated low frequency values. The curve shown in Fig. 2 gives the resulting free-field correction determined by the above described method.

The free-field corrections given are valid at 101.3 kPa, 23°C and 50% RH. The measurements have been performed at temperatures between 20°C and 22°C. This leads to a small systematic uncertainty.

The measurement of the free-field response and the electrostatic actuator response have been made in series. Changes in the frequency response of the microphone cartridge between the measurements has to be handled as a systematic uncertainty. The sum of these uncertainties (U_{95}) is below 0.085 dB at all frequencies.

Protection Grid Correction Measurement

The manufacturing uncertainties and uncertainties related to the combination of microphone and protection grid are the contributions to the uncertainty of the influence of the protection grid. The parameters investigated are:

- 1) Width of grooves
- 2) Length of grooves
- 3) Diameter of centre hole
- 4) Internal height of protection grid
- 5) Slit between the outside of the diaphragm ring and the inside of the protection grid

The above parameters were varied by several times the production tolerances, in order to have a measurable influence of the variations.

The influence of the protection grid is small at low frequencies, and increasing for increasing frequencies. At frequencies below 8 kHz the uncertainty (U_{95}) is below 0.1 dB. It is increasing to approximately 0.45 dB at the highest operating frequency for the microphone (see Fig. 3). The protection grid account for close to half of the total uncertainty for the free-field response.

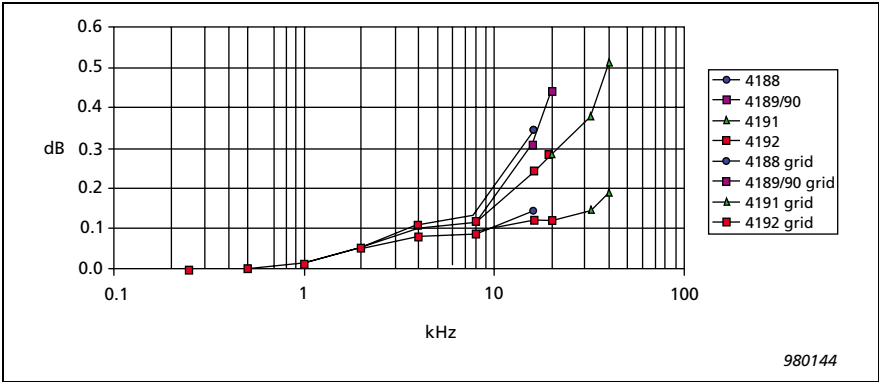

Fig. 3. Total free-field correction uncertainties for Brüel & Kjær Falcon Range microphones without and with protection grid. (U_{95}). The upper group of curves are with protection grid

Electrostatic Actuator Response Calibration

As mentioned earlier the response measured with an electrostatic actuator is generally influenced by the radiation impedance which loads the microphone diaphragm. The influence may be modified by the mechanical configuration of the actuator, the actuator type used for calibration service should be equal to that used for determination of the corrections.

The uncertainties used are estimated for “Calibration Services”, and they are due to systematic uncertainties of the frequency response for the measurement system, random uncertainties caused by acoustical noise and systematic uncertainties caused by differences in mechanical dimensions of the actuator. Mechanical resonances in the combination of electrostatic actuator, microphone, preamplifier housing and holder for preamplifier add to the uncertainties at frequencies above 5 kHz.

The resulting uncertainties for the electrostatic actuator calibration are shown in Fig. 4.

The “Factory Calibration” performed at Brüel & Kjær resulting in a Calibration Chart and a Data Diskette have lower uncertainty values. This is due to the very low systematic uncertainty on the frequency response of the measuring system.

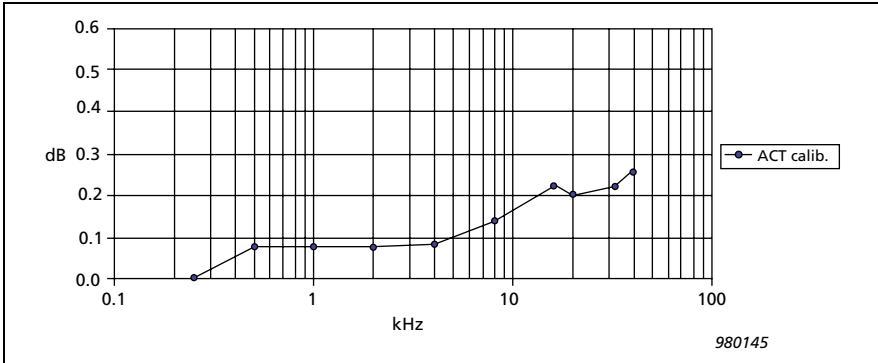

Fig. 4. Total electrostatic actuator calibration uncertainties for Brüel & Kjær Falcon Range microphones (U_{95})

Free-field Response Uncertainties

The different contributions to the total uncertainty are shown for all Brüel & Kjær Falcon Range microphones without and with protection grid in Fig. 5. The electrostatic actuator calibration is the main contributor at low and medium frequencies. At the highest frequencies the protection grid is dominant. This picture is typical for all the Falcon Range microphones.

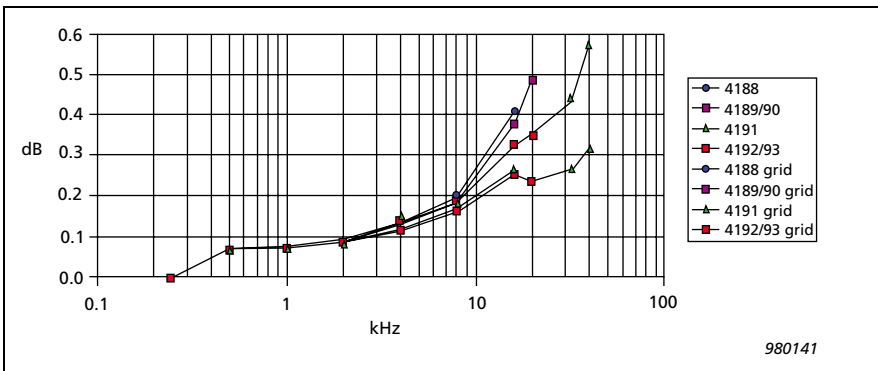

Fig. 5. Total uncertainties for Brüel & Kjær Falcon Range microphones without and with protection grid (U_{95}). The upper group of curves are with protection grid

Comments

From the measurement results for the free-field correction some interesting analysis can be performed. If the free-field corrections for all the 6 Brüel & Kjær Falcon Range microphones are plotted on the same graph (see Fig. 6) it is seen that there are noticeable differences already at 2 kHz. The difference is increasing towards higher frequencies. In Fig. 7 the maximum difference is shown both for the measured and the calculated (BEM) free-field correction. The interesting thing about these results is that seen from the outside there are no differences between the microphones without protection grid.

The differences in Fig. 7 are caused by the differences in diaphragm impedance and damping of the diaphragm. For other 1/2" microphones with different mechanical configuration around the diaphragm even larger differences in free-field corrections can be expected.

This leads to the conclusion, that it is very important that the free-field correction is actually measured for the microphone type for which it is used during calibration. It is not enough to use the free-field correction of a seemingly similar microphone type.

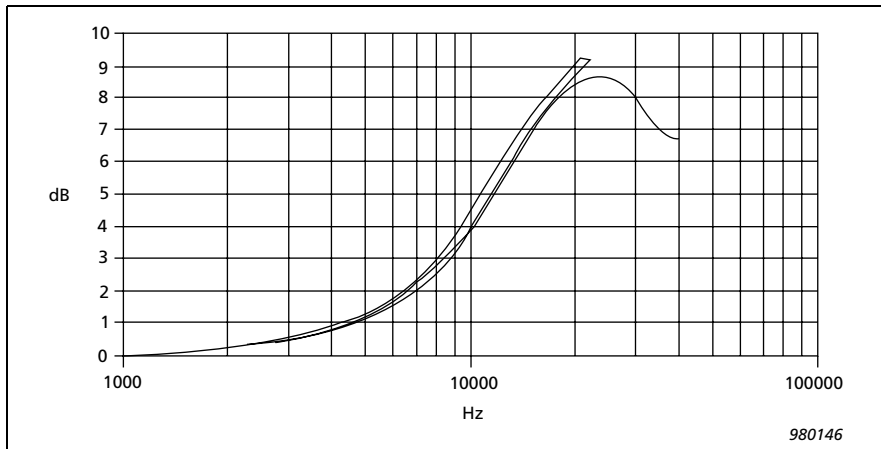

Fig. 6. Free-field correction for 6 different 1/2" Brüel & Kjær Falcon Range microphones without protection grid

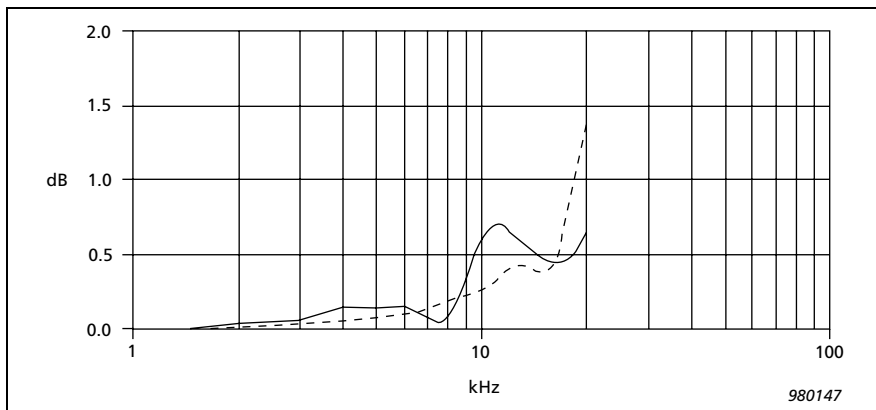

Fig. 7. Difference in free-field correction for 6 different 1/2" Brüel & Kjær Falcon Range microphones with exactly the same mechanical configuration around the diaphragm
 --- Boundary Element Calculation
 — Brüel & Kjær measurements

Conclusion

For each of the Brüel & Kjær Falcon Range microphones uncertainty values have been presented relating to:

- 1) free-field correction
- 2) influence of protection grid
- 3) electrostatic actuator calibration

The total uncertainty (U_{95}) of the free-field response for the Brüel & Kjær Falcon Range microphones with protection grid are typically below 0.1 dB for frequencies up to 2 kHz, below 0.25 dB up to 10 kHz and increasing to between 0.35 dB and 0.58 dB at the highest operating frequency.

The uncertainty of the free-field response can be reduced approximately 50% by using the microphone without protection grid.

For other microphones larger uncertainties for the free-field response can be expected.

As microphone frequency responses are generally not accompanied by the corresponding uncertainty values, the frequency response for measurement microphones are a question of confidence.

References

- [1] Erling Frederiksen, Johan Gramtorp, “*Measurement of Microphone Free-field Corrections and Determination of their Uncertainties*”, Brüel & Kjær: Technical Review No. 1–1996, 9–18 (and ICA95, 15th International Congress on Acoustics, proceedings IV, 209–212)
- [2] IEC 61094–2, “*Primary method for pressure calibration of laboratory standard microphones by the reciprocity technique*”
- [3] IEC 61094–3, “*Primary method for free-field calibration of laboratory standard microphones by the reciprocity technique*”
- [4] Peter Juhl, “*Numerical Investigation of Standard Condenser Microphones*”, Journal of Sound and Vibration 1994 Vol. 177 (4), 433– 446

Measurement of Microphone Random-incidence and Pressure-field Responses and Determination of their Uncertainties *

by Johan Gramtorp and Erling Frederiksen

Abstract

For many applications it is important to know the frequency response of the measurement microphone. In two earlier papers [1] & [2] the determination of the free-field response and the uncertainties of the responses based on actuator calibration for 1/2" microphones were discussed. This paper continues by discussing actuator based pressure-field and random-incidence responses and their uncertainties. From most manufacturers no information on the uncertainties is available. A complete set of uncertainty values for pressure-field and random-incidence corrections and responses for the Brüel&Kjær Falcon Range 1/2" microphones will be presented and discussed.

Résumé

Il est important, dans de nombreuses applications, de connaître la réponse en fréquence du microphone de mesurage. Dans deux articles précédents [1] & [2], la détermination de la réponse en champ libre et l'incertitude des réponses basées sur le calibrage des microphones de 1/2" ont été discutées. Le présent article poursuit ce thème en discutant réponses et incertitudes en champ de pression et incidence aléatoire. La plupart des constructeurs ne fournissent aucune information sur ces incertitudes. Cet article présente et discute un ensemble de valeurs d'incertitude pour les réponses et corrections des mesures en champ de pression et avec incidence aléatoire pour les Microphones 1/2" de la gamme Falcon Brüel & Kjær.

* First presented at ICA 1998

Zusammenfassung

Bei vielen Anwendungen ist es wichtig, den Frequenzgang des Meßmikrofons zu kennen. In zwei früheren Beiträgen ([1] und [2]) wurde die Ermittlung des Freifeld-Frequenzgangs und der damit verbundenen Unsicherheiten anhand der Kalibrierung von 1/2"-Mikrofonen mit Kalibrier-gittern diskutiert. Dieser Beitrag setzt die Betrachtungen mit einer Diskussion des Druck- und Diffusfeld-Frequenzgangs und der Unsicherheiten auf der Basis von Kalibriergittern fort. Die meisten Hersteller machen keine Angaben über die Meßunsicherheit. Es wird ein kompletter Datensatz mit Meßunsicherheiten für Druck- und Diffusfeldkorrekturen und Frequenzgänge für die neuen 1/2"-Mikrofone der Falcon-Serie von Brüel & Kjær vorgestellt und diskutiert.

Pressure-field Response

Until now most of the pressure-field responses for "Working Standard" microphones presented on calibration charts, have actually been electrostatic actuator responses. They differ slightly from the true pressure-field response due to the radiation impedance of the microphone diaphragm.

The Brüel & Kjær Falcon Range 1/2" microphones can, due to the very robust diaphragm clamping technique, fit directly into reciprocity calibration couplers. Based on pressure-field reciprocity measurements performed in different couplers and the corresponding electrostatic actuator response, it is thereby possible to determine a type specific pressure-field correction as shown in Fig. 1.

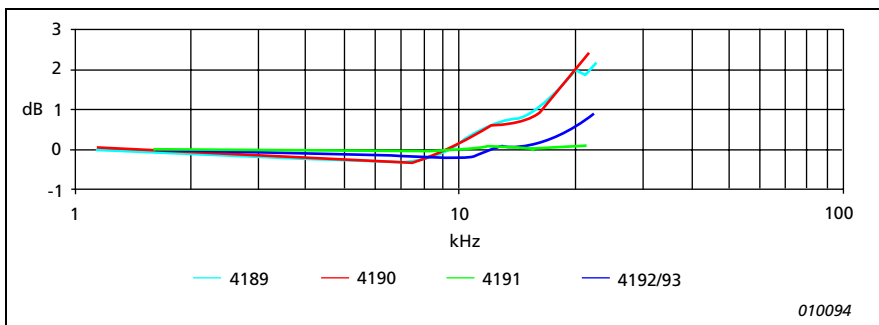

Fig. 1. Pressure-field corrections for Brüel & Kjær Falcon Range 1/2" microphones based on pressure-field reciprocity measurements

The individual pressure-field response for any of these microphones can now be determined by adding the type specific pressure-field correction to the individually measured electrostatic actuator response. The uncertainties for the pressure-field corrections are dominated by the uncertainties from the pressure-field reciprocity measurement. The total uncertainties shown in Table 1 are dominated by the uncertainties from the electrostatic actuator calibration.

Microphone Type	0.25kHz	0.5kHz	1 kHz	2 kHz	4 kHz	8 kHz	16 kHz	20 kHz
4189-93	0 dB	0.07 dB	0.07 dB	0.07 dB	0.11 dB	0.16 dB	0.25 dB	0.27 dB

Table 1. Pressure-field response uncertainties U_{95} for Brüel & Kjær Falcon Range 1/2" microphones based on actuator calibration

Random-Incidence Response

The random-incidence responses presented on the calibration charts are based on a large number of free-field measurements with different angles of incidence increased in small steps, and calculated as a weighted sum according to IEC 60651 or 61183, combined with electrostatic actuator calibration. Until now most of the random-incidence responses, have been calculated from measurements performed in 30° angle steps according to IEC 651 (now IEC 60651).

The Brüel & Kjær Falcon Range 1/2" microphones has been measured in 5° angle steps and calculated according to IEC 61183. These measurements are normalised with the 0°-incidence free-field reciprocity response for the microphone.

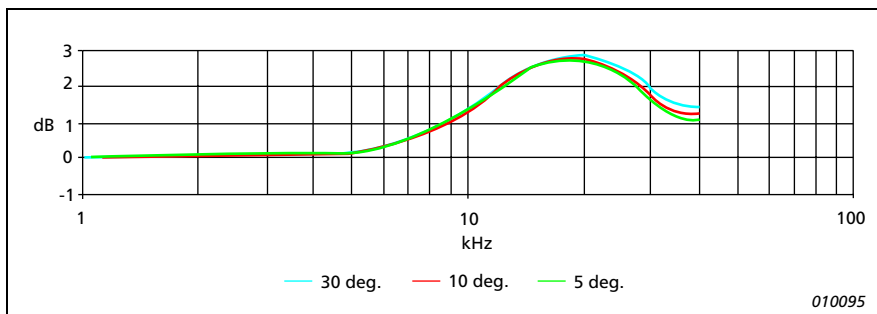

Fig. 2. Random-incidence correction for Brüel & Kjær Type 4191 microphone calculated from free-field corrections in different angle steps

When the random-incidence correction is calculated in different angle steps on the same measurement data, the differences are very small up to 15 kHz as shown on Fig. 2. Above 15 kHz the differences increase to approximately 0.4 dB at 40 kHz. The uncertainties for the random-incidence corrections (calculated in 5° angle steps) are dominated by the differences in the measurements for + and – angles and the uncertainties from the influence of the protection grid.

The total uncertainties on the random-incidence responses, shown in Table 2, have almost equal contributions from the random-incidence correction and the electrostatic actuator calibration below 8 kHz. Above 8 kHz the uncertainties on the random-incidence correction becomes dominating.

Microphone Type	0.25 kHz	0.5– 2 kHz	4 kHz	8 kHz	16 kHz	20 kHz	32 kHz	40 kHz
4188 with DZ 9566	0 dB	0.14 dB	0.17 dB	0.23 dB	0.44 dB			
4189/90	0 dB	0.10 dB	0.15 dB	0.19 dB	0.55 dB	0.63 dB		
4191	0 dB	0.10 dB	0.15 dB	0.19 dB	0.34 dB	0.37 dB	0.75 dB	0.99 dB
4192/93	0 dB	0.10 dB	0.15 dB	0.19 dB	0.34 dB	0.37 dB		

Table 2. Random-incidence response uncertainties U_{95} for Brüel & Kjær Falcon Range 1/2" microphones based on actuator calibration

Conclusion

We have come from pressure-field responses, that were actually electrostatic actuator responses to closed coupler pressure-field responses, and from random-incidence responses based on measurements performed in 30° angle steps to measurements performed in 5° angle steps. The responses can now be accompanied by the corresponding uncertainties instead of only being a thin line on the calibration chart.

References

- [1] Gramtorp, J and Frederiksen, E, "Frequency response for measurement microphones: a question of confidence", Honolulu, ASA December 1996
- [2] Frederiksen, E and Gramtorp, J, Brüel & Kjær: Technical Review No.1 - 1996, "Measurement of Microphone Free-field Corrections and Determination of their Uncertainties", 9 – 18 (and proceedings of ICA95 15th International Congress on Acoustics, Trondheim, Norway, IV 209 –212, 1995)

Previously issued numbers of Brüel & Kjær Technical Review

(Continued from cover page 2)

- 1 – 1987 Vibration Monitoring of Machines
- 4 – 1986 Field Measurements of Sound Insulation with a Battery-Operated Intensity Analyzer
Pressure Microphones for Intensity Measurements with Significantly Improved Phase Properties
Measurement of Acoustical Distance between Intensity Probe Microphones
Wind and Turbulence Noise of Turbulence Screen, Nose Cone and Sound Intensity Probe with Wind Screen
- 3 – 1986 A Method of Determining the Modal Frequencies of Structures with Coupled Modes
Improvement to Monoreference Modal Data by Adding an Oblique Degree of Freedom for the Reference
- 2 – 1986 Quality in Spectral Match of Photometric Transducers
Guide to Lighting of Urban Areas
- 1 – 1986 Environmental Noise Measurements
- 4 – 1985 Validity of Intensity Measurements in Partially Diffuse Sound Field
Influence of Tripods and Microphone Clips on the Frequency Response of Microphones
- 3 – 1985 The Modulation Transfer Function in Room Acoustics
RASTI: A Tool for Evaluating Auditoria
- 2 – 1985 Heat Stress
A New Thermal Anemometer Probe for Indoor Air Velocity Measurements

Special technical literature

Brüel & Kjær publishes a variety of technical literature which can be obtained from your local Brüel & Kjær representative.

The following literature is presently available:

- Catalogues (several languages)
- Product Data Sheets (English, German, French,)

Furthermore, back copies of the Technical Review can be supplied as shown in the list above. Older issues may be obtained provided they are still in stock.

BY0054-11 ISSN 0007-2621

HEADQUARTERS: DK-2850 Nærum · Denmark
Telephone: +45 45 80 05 00 · Fax: +45 45 80 14 05
Internet: <http://www.bksv.com> · e-mail: info@bksv.com

Brüel & Kjær 